

Kauri Glen Stage Three

Option One: Tree Top high boardwalk and Bridge

Option Two: Long staircase and boardwalk down and up the gully

Presented by:

Auckland Council: Leigh Radovan, Grant Jennings, Lisa Tolich

22 September 2021



Funding for Kauri Glen Stage Three

Kauri Glen Reserve was identified as a priority Kaipatiki park to protect healthy kauri from the threat of kauri dieback disease. It is a significant ecological area and neither the pathogen nor the disease has been detected within this reserve.

The work will be funded through two main investment streams:

- The Natural Environment Targeted Rate (NETR) provides funding for kauri dieback management interventions, including new infrastructure to upgrade tracks to a national kauri protection standard
- The Kaipatiki Local Board have renewals funding to upgrade existing structures that are in need of work to bring them up to Auckland Council standards.

Stages of work for Kauri Glen Reserve (stages 1 and 2 now complete):

- Stage one: co-funded by local board renewal and NETR
- Stage Two was funded by NETR
- Stage Three – discussion on which option the local board prefer.
 - NETR sponsors have identified that they will commit \$669,632 (capped) for option two to provide a long staircase up and down the gully will meet the sufficient requirements to protect the Kauri.
 - If Kaipatiki Local Board prefer option one, then they are requested to fund the difference of \$340,170 and any further variations that MAY occur for this option.

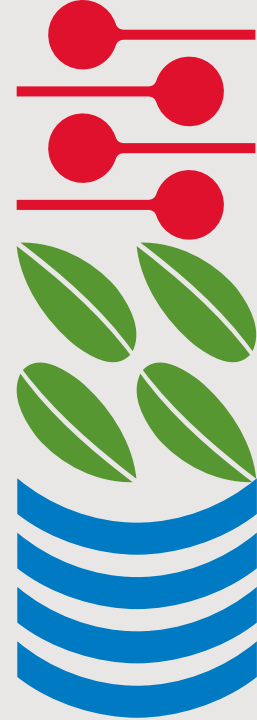

- Renew Existing Track
- Proposed Bridge
- Proposed Boardwalk
- Existing Track (No works)
- Decommission Existing Track
- Kauri tree



Kauri Glen Reserve Stage Three Option One

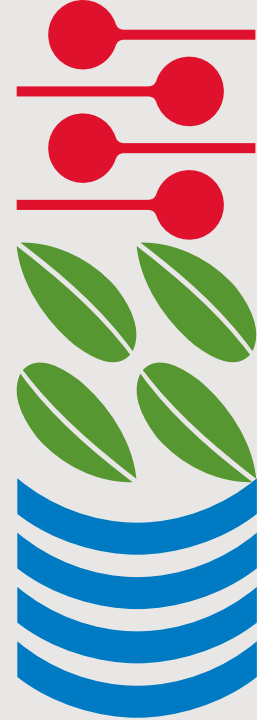
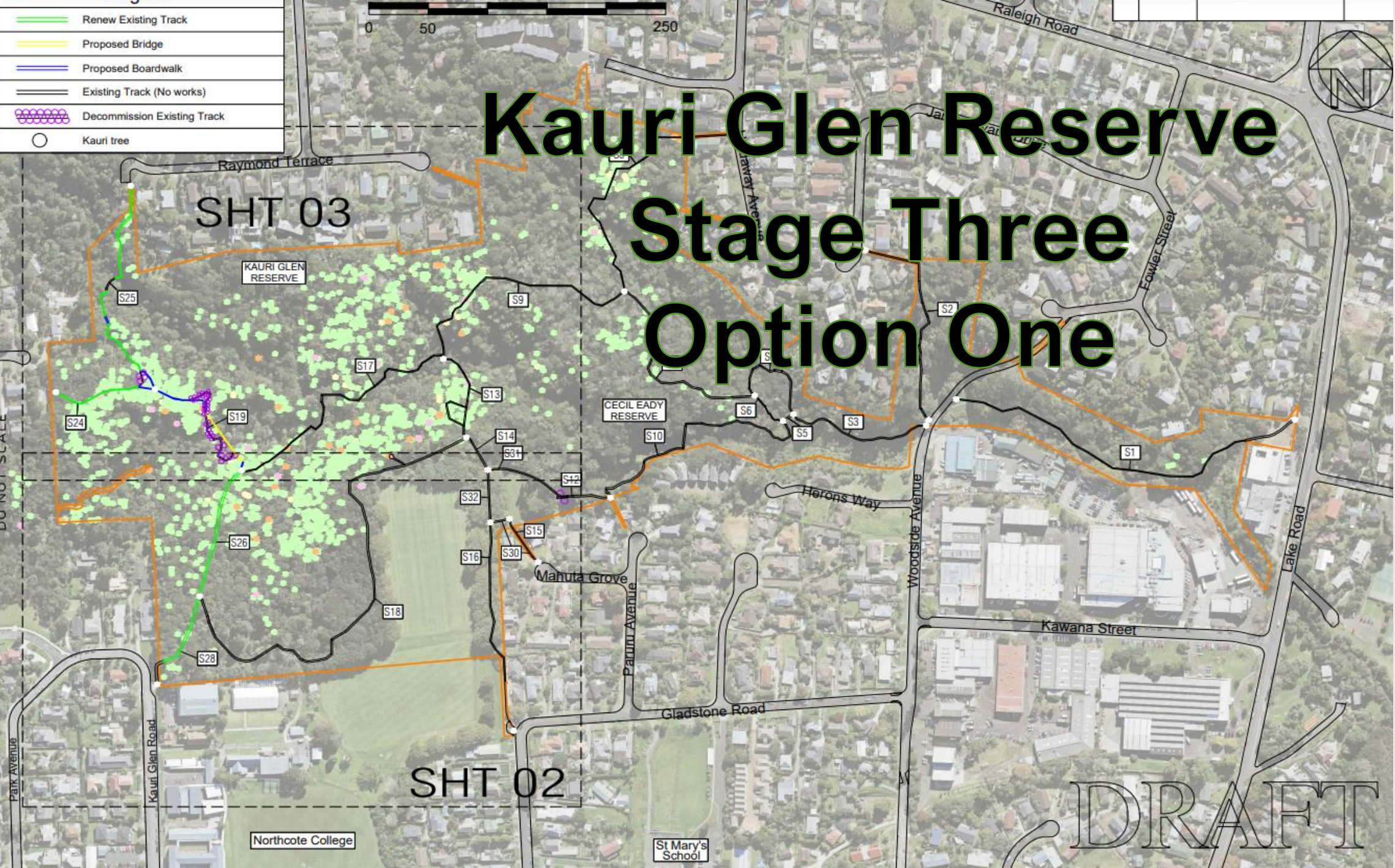

DRAFT

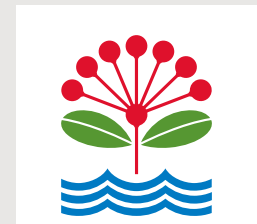

Kauri Glen Stage Three – Option One

Tree Top high boardwalk and Bridge

- This spans the top of the gully
- Raised boardwalk 1.5m wide
- Low boardwalk 1.5m wide
- 3 span Glulam bridge 1.5m wide with sections up to 3.0m wide.
- Handrail designed to a cycleway standard with a no climb barrier (1.2 m high and sloping)
- Requires building consent
- Engineers have incorporated a hand-dig approach to piles within the sensitive K10-K12 pile areas to allow for probing and relocation of piles. Pile holes will be lined with plastic to create a separation between sensitive root system and concrete.
- Consultants have completed a full tender package with Engineers Estimate and is ready to go out for tender.
- Arborist and Ecological Reports support Option One. This assumes a lesser impact overall and that additional fill will be used to improve hydrology and restore existing track to its original condition. No longer will the track be acting as a drain.
- Costs: \$1,009,820 (Engineers Estimate with full tender package including costs of scaffolding) – NETR Capped figure of \$669,632 – local board to contribute \$340,170
- The ongoing temporary closures of Raymond and Tui entrances including to the junction of S26 to S28 (during physical Works).
- Upgrade from Raymond and Tui Terrace up to S26 with a hygiene station at each end.
- Helicopter drops will be a necessary part of this project.



Rev	Date	Amendment	Drawn
A	27/07/21	BUILDING CONSENT ISSUE	JR

14 BRIDGE / BOARDWALK FULL PLAN

SHT - 1:400 @ A3

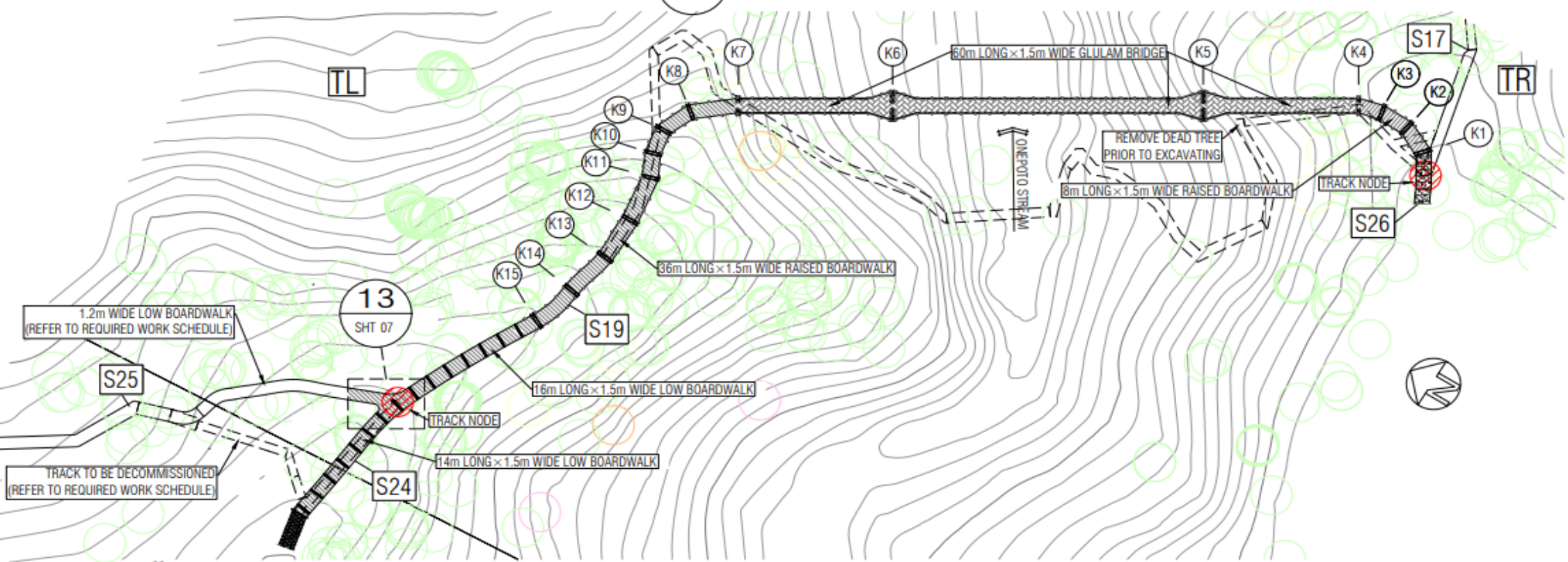

15 BRIDGE / BOARDWALK ELEVATION

SHT - 1:400 @ A3

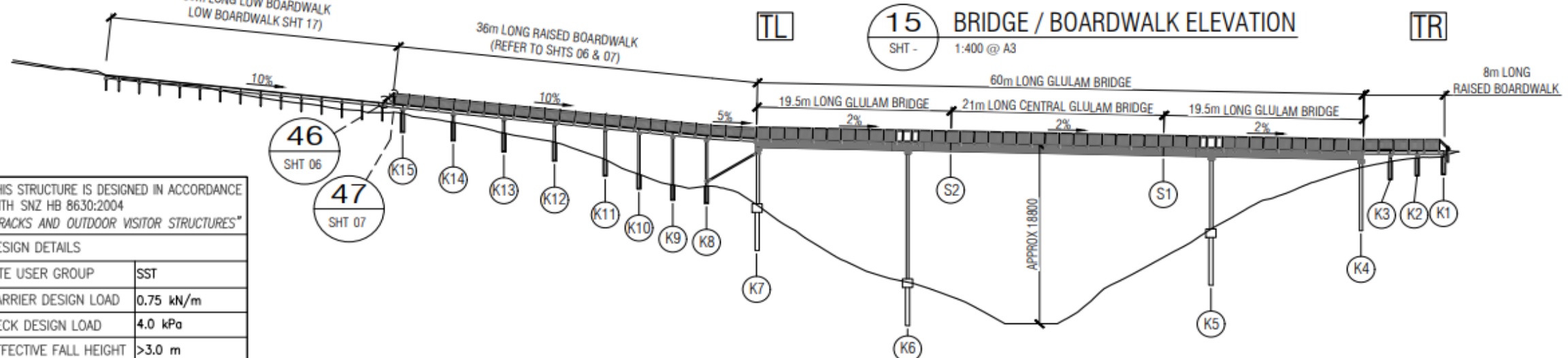

DO NOT SCALE

THIS STRUCTURE IS DESIGNED IN ACCORDANCE WITH SNZ HB 8630:2004 "TRACKS AND OUTDOOR VISITOR STRUCTURES"

DESIGN DETAILS	
SITE USER GROUP	SST
BARRIER DESIGN LOAD	0.75 kN/m
DECK DESIGN LOAD	4.0 kPa
EFFECTIVE FALL HEIGHT	>3.0 m



S19 High Boardwalk and Bridge

2	S19: Main Bridge Section				
2.1.1	Remove and dispose of existing edgeboard, steps and bridge timber, and decommissioning of disused track sections	1	LS	5,000	5,000
2.1.2	Removal of approximately 24 trees by qualified arborist as per Arboricultural report.	1	LS	20,000	20,000
2.1.3	Provide temporary scaffolding for support and access to S19 bridge	1	LS	45,000	45,000
2.2	Raised boardwalk, 1.5m wide (K1-K4, K7-K15)				
2.2.1	Supply and install 200 SED timber pile sets for raised boardwalk at K1, K2, K3, K8, K9, K10, K11, K12, K13, K14 and K15, ranging in height approximately 0.3m to 5.0m (including probing, excavation of 1.8m deep holes, installation of two timber piles, in plastic lined concrete filled holes, bracing, bearers, brackets and bolts)	11	Each	900	9,900
2.2.2	Supply and install 1.5m wide raised boardwalk (including 300x50 joists, blocking, decking, fixings, non-slip material etc)	44	Lin m	950	41,800
2.2.3	Supply and install steel infill barriers (including baluster posts, steel infill panels, brackets, screws, bolts, timber packer, top rail and top rail end termination)	94	Lin m	450	42,300
2.3	Low boardwalk, 1.5m wide (K15 - S19/S24/S25 Junction)				
2.3.1	Supply and install 90 SED timber pile sets for low boardwalk (including probing, installation of two driven timber piles 0.9m minimum depth and installation of bearers and bolts)	8	Each	450	3,600
2.3.2	Supply and install 1.5m wide low boardwalk (including 150x50 joists, blocking, decking, fixings, non-slip material etc)	16	Lin m	550	8,800

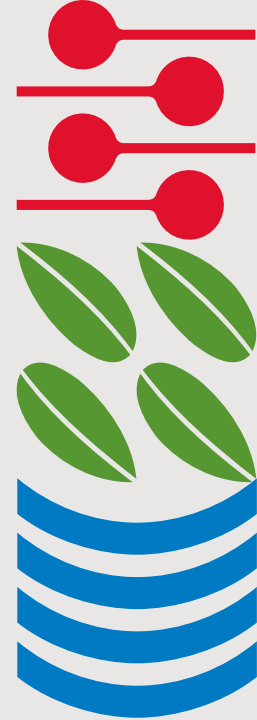

2.4	Pier K4				
2.4.1	Supply and install approximately 0.5m high pier (including excavation of 6.0m deep holes, installation of three 200 SED timber piles in plastic lined concrete filled holes and installation of bearers, bolts and brackets)	1	LS	9,900.00	9,900
2.5	Foundation and Pier K5				
2.5.1	Supply and install five 5.3m long piles (including excavation of 5.0m deep holes, installation of 200 SED piles in plastic lined concrete filled holes)	1	LS	8,700.00	8,700
2.5.2	Supply and install 1.0m x 1.0m x 6.0m long concrete pile cap (including forming, reinforcing steel, concrete placement, curing and stripping)	1	LS	13,200.00	13,200
2.5.3	Supply and install pier consisting four approximately 8m long x 300 SED timber poles, bolts, horizontals, bearers, cross bracing, packer and pole fixing	1	LS	10,800.00	10,800
2.6	Foundation and Pier K6				
2.6.1	Supply and install five 4.3m long piles (including excavation of 4.0m deep holes, installation of 200 SED piles in plastic lined concrete filled holes)	1	LS	6,900	6,900
2.6.2	Supply and install 1.0m x 1.0m x 6.0m long concrete pile cap (including forming, reinforcing steel, concrete placement, curing and stripping)	1	LS	13,200	13,200
2.6.3	Supply and install pier consisting four approximately 13.6m long x 300 SED timber poles, bolts, horizontals, bearers, cross bracing, packer and pole fixing	1	LS	18,900	18,900
2.7	Foundation and Pier K7				
2.7.1	Supply and install three 4.3m long piles (including excavation of 4.0m deep holes, installation of 200 SED piles in plastic lined concrete filled holes)	1	LS	4,200	4,200
2.7.2	Supply and install 1.0m x 1.0m x 3.600m long concrete pile cap (including forming, reinforcing steel, concrete placement, curing and stripping)	1	LS	7,900	7,900
2.7.3	Supply and install pier consisting four approximately 6m long x 300 SED timber poles, bolts, horizontals, bearers, cross bracing, packer and pole fixing	1	LS	8,100	8,100

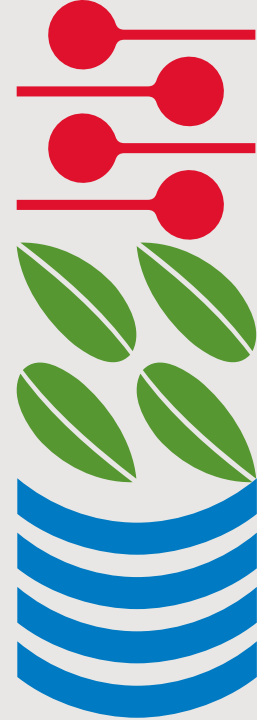

2.8	Main Bridge Superstructure				
2.8.1	Supply and install glulam beam bridge structure (including four 945x90 beams, blocking, bracing and fixing/brackets)	60	Lin m	4,900	294,000
2.8.2	Fabricate and install beam splice fittings and S1 and S2 (including bracket fabrication and fixings)	8	Each	850	6,800
2.8.3	Supply and install bridge widening each side at K5 and K6 (including 945x90 edge beam, blocking, fixings)	4	Each	5,800	23,200
2.8.4	Supply and install decking and non slip mesh (including widening sections at K5 and K6)	60	Lin m	380	22,800
2.8.5	Supply and install barrier (including baluster posts, steel infill panels, brackets, screws, bolts, timber top rail)	112	Lin m	450	50,400
2.8.6	Supply and install artwork barrier (including baluster posts, laser cut infill panels, stainless steel top rail, brackets, screws and bolts)	9	Lin m	650	5,850
				S19 Sub-total:	\$ 681,250



Engineers Estimate for Option One: \$1,009,802

NETR Contribution

\$669,632

Kaipatiki Capex Contribution

\$340,170



DO NOT SCALE

16 DETAILED BRIDGE PLAN

SHT - 1:250 @ A3

Rev	Date	Amendment	Drawn
A	27/07/21	BUILDING CONSENT ISSUE	JR

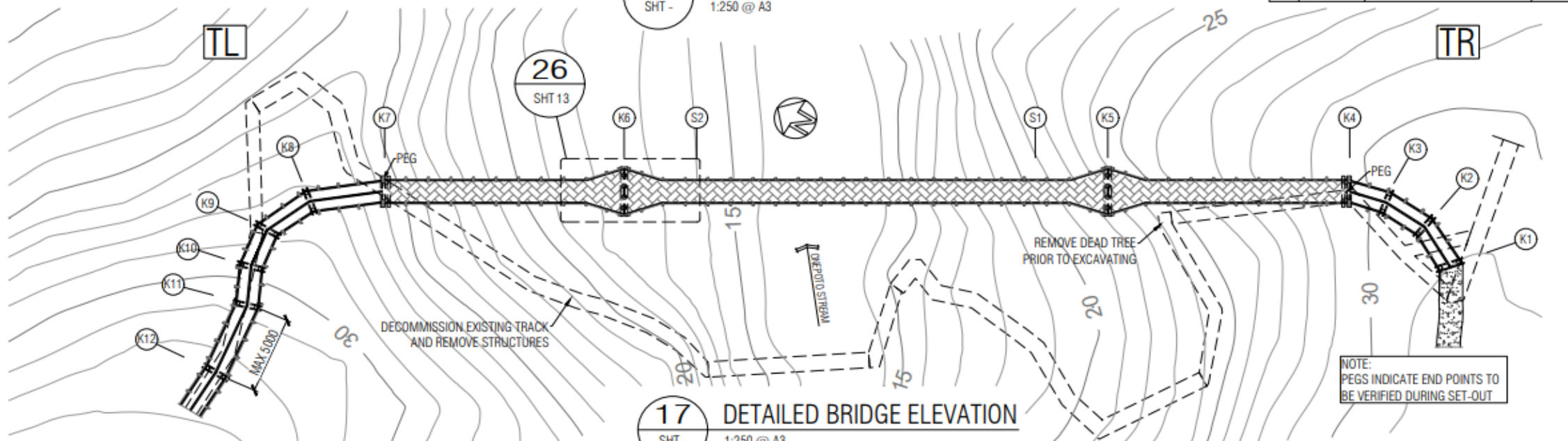

17 DETAILED BRIDGE ELEVATION

SHT - 1:250 @ A3

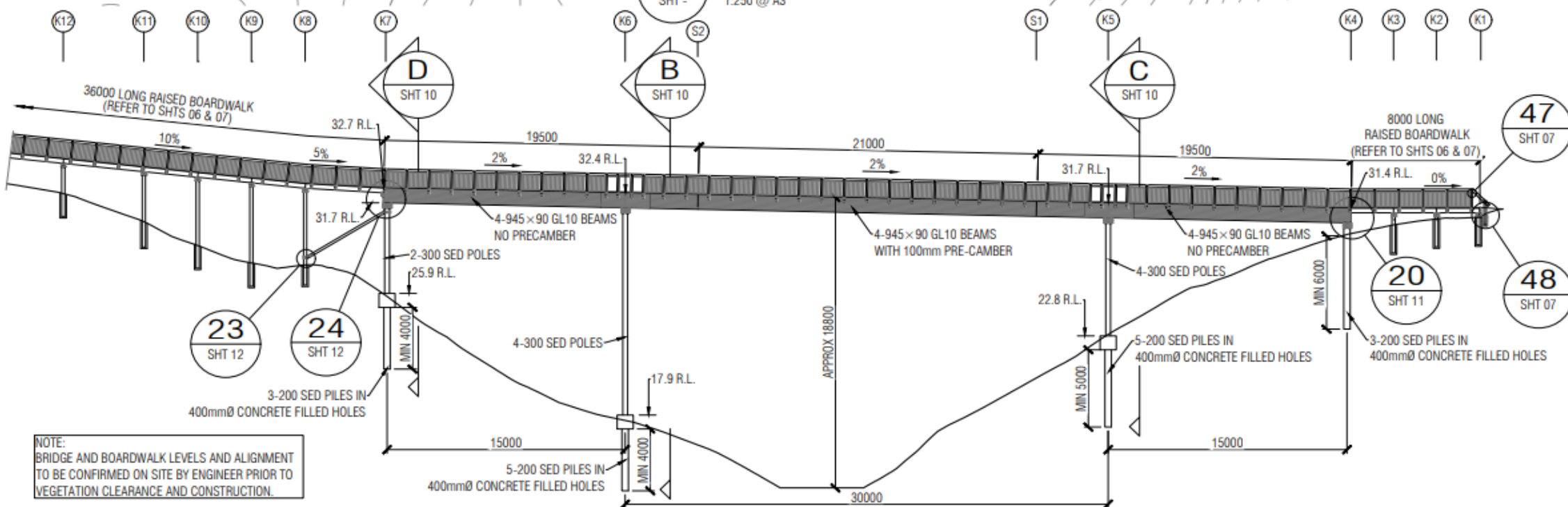

DO NOT SCALE



06 RAISED BOARDWALK PART ELEVATION

SHT - 1:50 @ A3

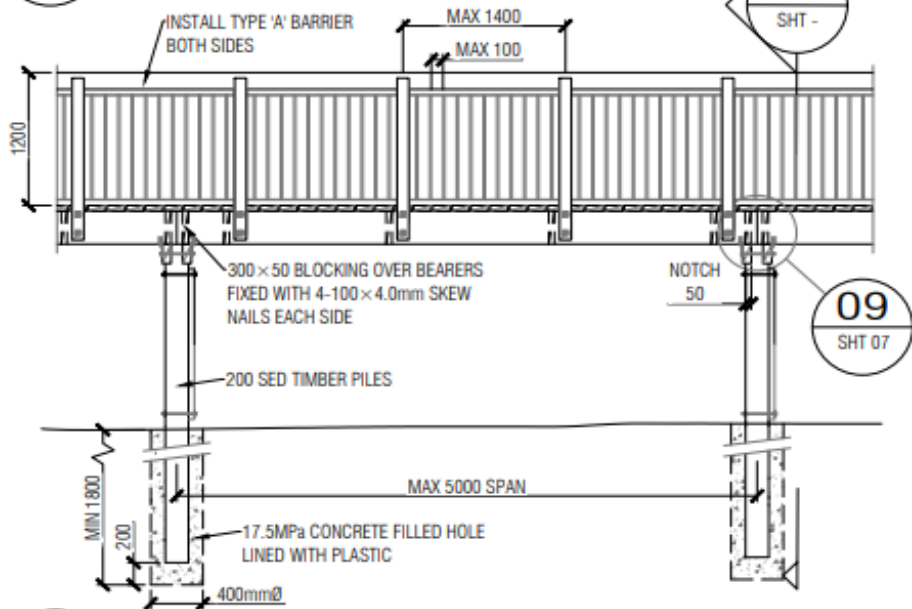

07 TYPICAL CURVE DETAIL

SHT - 1:20 @ A3

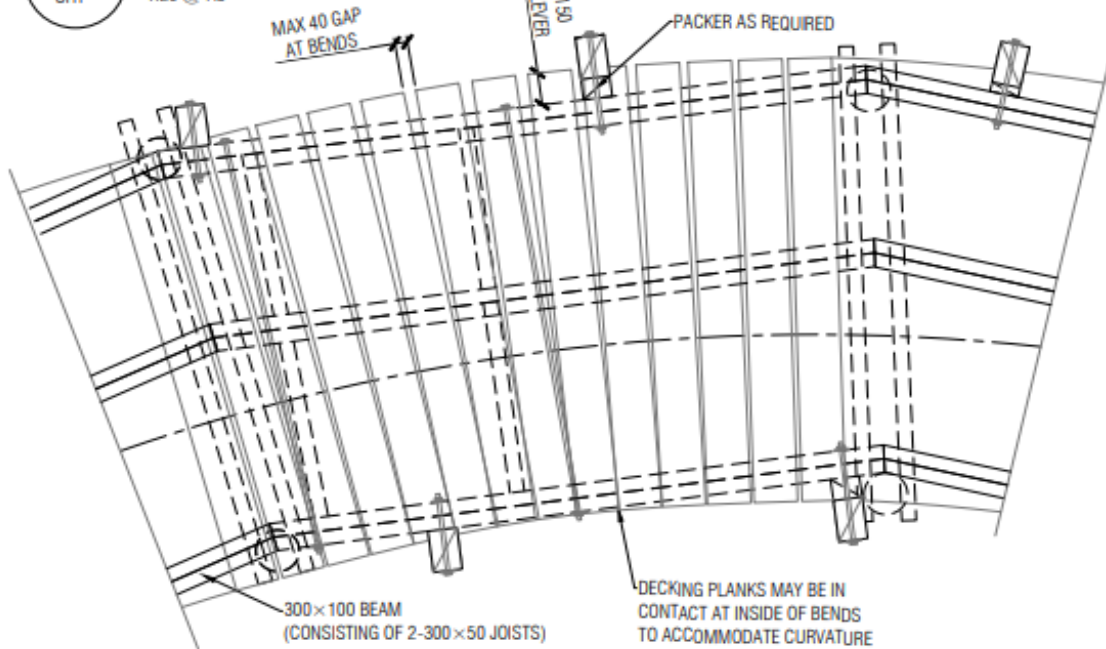

A RAISED BOARDWALK SECTION

SHT - 1:20 @ A3

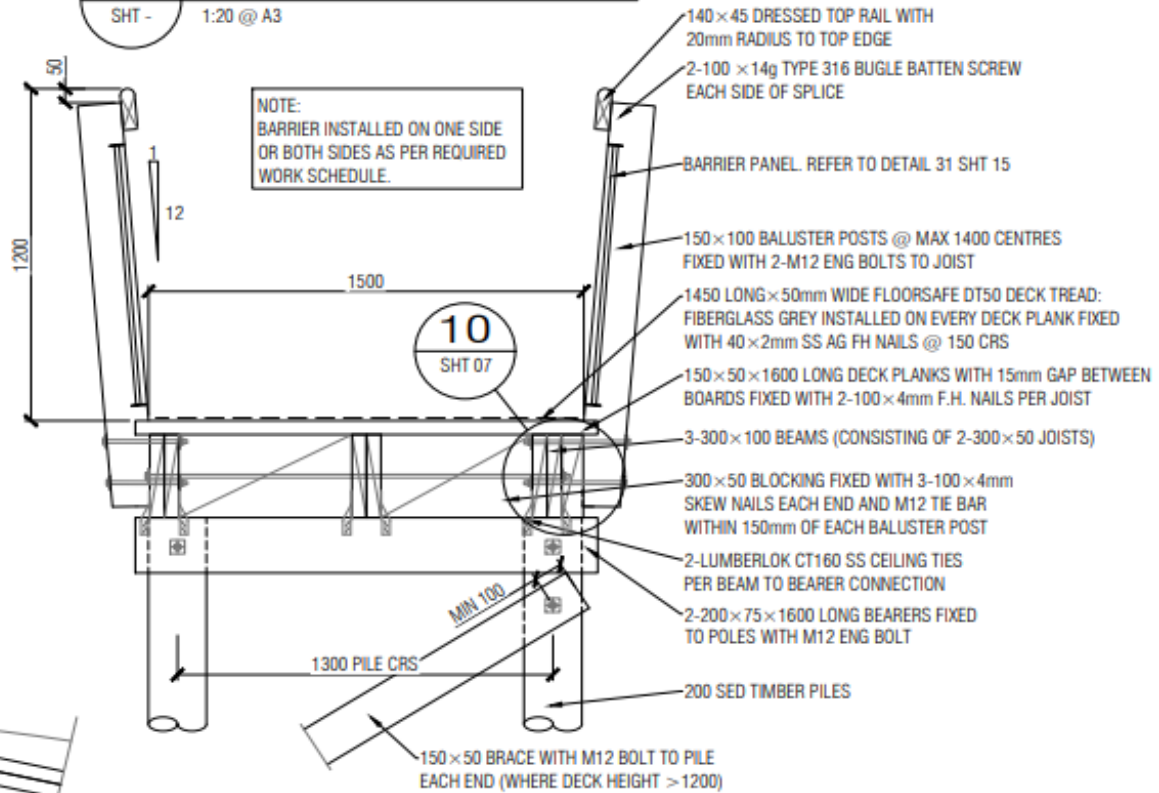

46 FLARED END RAIL DETAIL

SHT - 1:20 @ A3

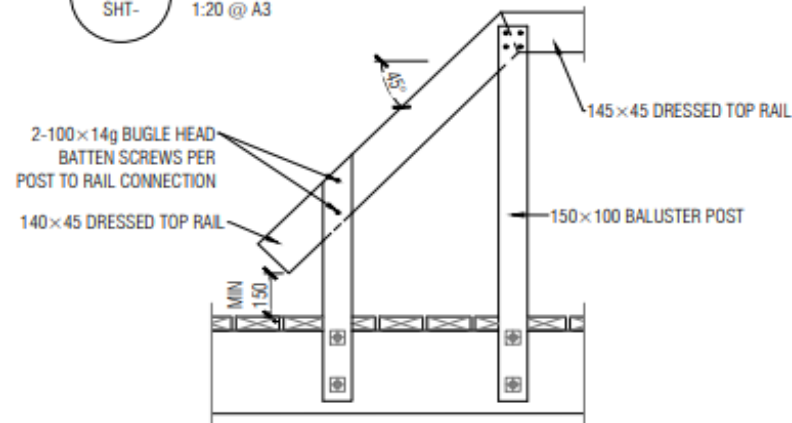

THIS STRUCTURE IS DESIGNED IN ACCORDANCE WITH SNZ HB 8630:2004 "TRACKS AND OUTDOOR VISITOR STRUCTURES"

DESIGN DETAILS

SITE USER GROUP	SST
BARRIER DESIGN LOAD	0.75 kN/m
DECK DESIGN LOAD	4.0 kPa
EFFECTIVE FALL HEIGHT	>3.0 m



DO NOT SCALE

34 BRIDGE DECKING LAYOUT

SHT - 1:25 @ A3

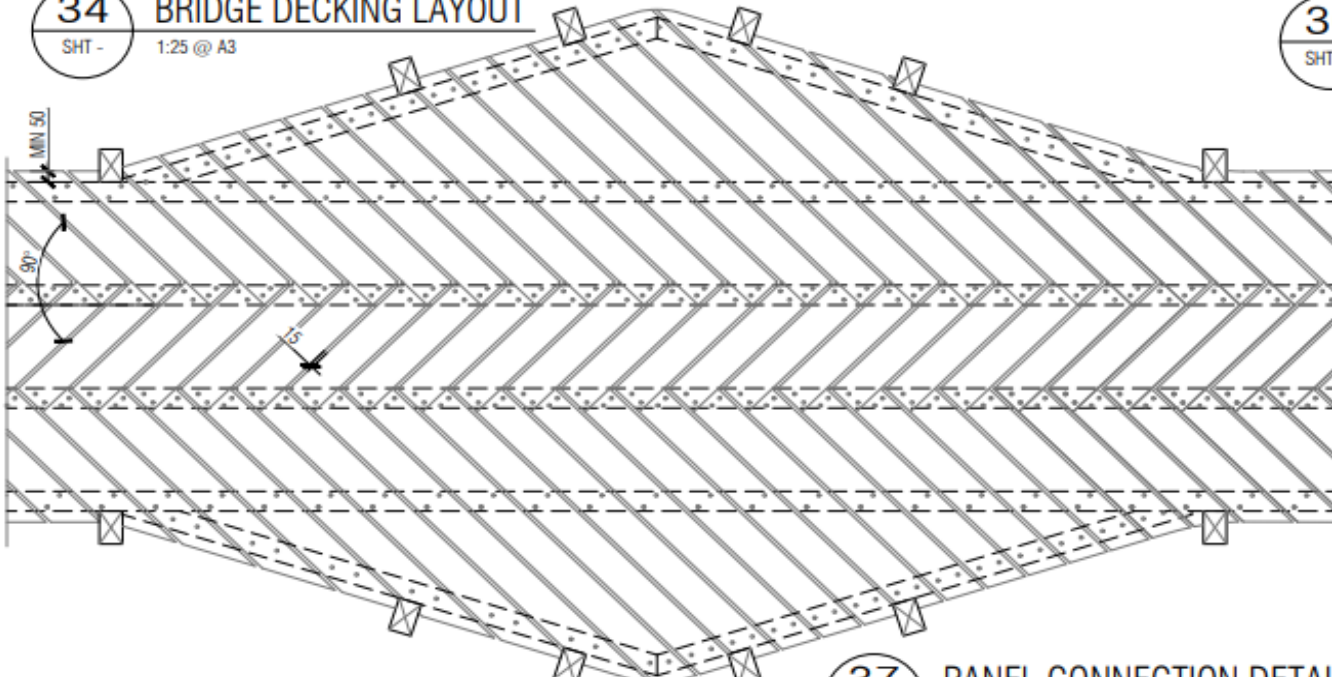

35 TYPICAL BARRIER PANEL ELEVATION

SHT 13 1:20 @ A3

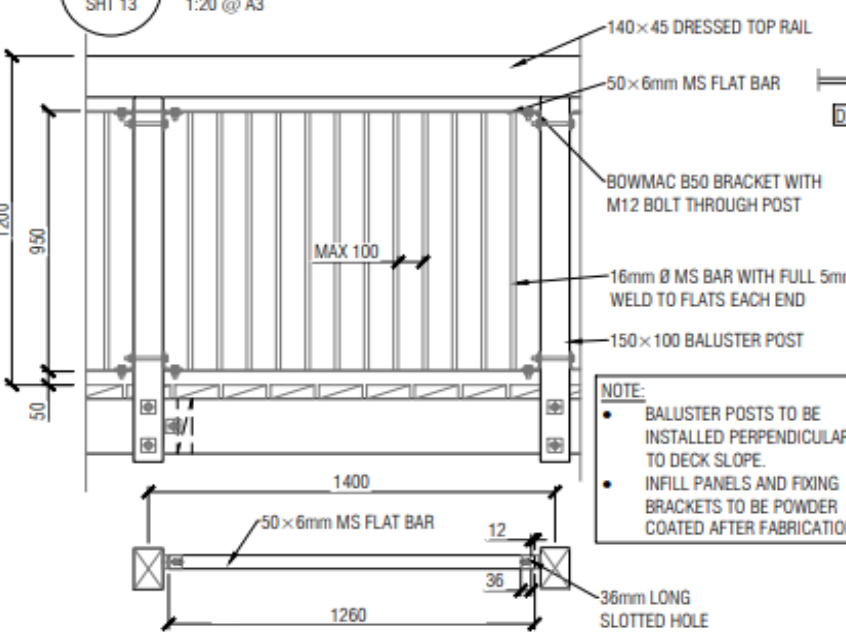

NOTE:

- BALUSTER POSTS TO BE INSTALLED PERPENDICULAR TO DECK SLOPE.
- INFILL PANELS AND FIXING BRACKETS TO BE POWDER COATED AFTER FABRICATION.

37 PANEL CONNECTION DETAIL

SHT - 1:10 @ A4

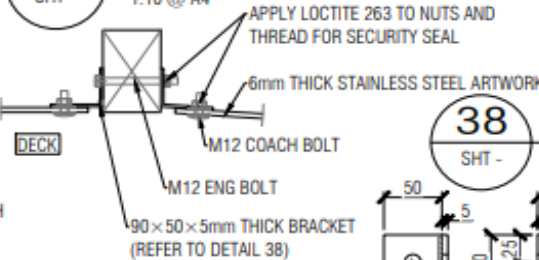

36 ARTWORK PANEL ELEVATION

SHT 13 1:20 @ A4

50mm NB x APPROX 2230 LONG STAINLESS STEEL PIPE AND END CAPS BENT TO MATCH ARTWORK AT APEX (REFER TO SECTION F SHT 15 FOR CONNECTION DETAIL)

END PANEL - 8 TOTAL: 1085 HIGH x APPROX 595 LONG x 6mm THICK LASERCUT STAINLESS STEEL ARTWORK PANEL MEASUREMENTS TO BE CONFIRMED ONSITE PRIOR TO FABRICATION (INDICATIVE ONLY - ARTWORK TO BE SUPPLIED)

APEX (CENTRAL) PANEL - 4 TOTAL: 1085 HIGH x APPROX 600 LONG x 6mm THICK LASERCUT STAINLESS STEEL ARTWORK PANEL CURVED TO FIT PANEL MEASUREMENTS TO BE CONFIRMED ONSITE PRIOR TO FABRICATION (INDICATIVE ONLY - ARTWORK TO BE SUPPLIED)

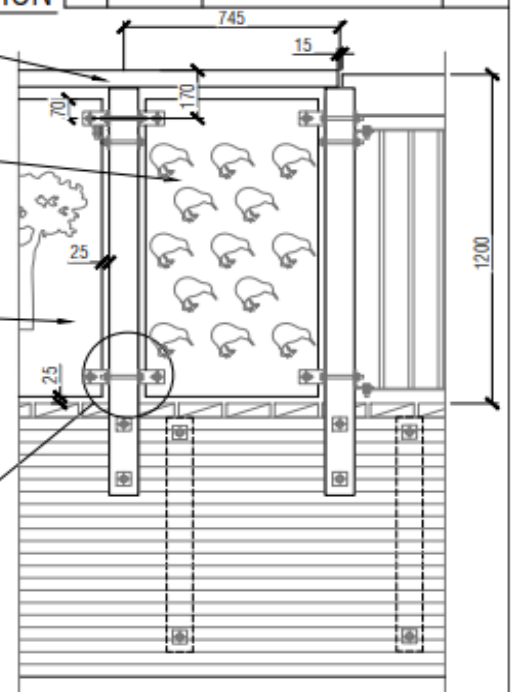

37 SHT -

38 BRACKET DETAIL

SHT - 1:5 @ A4

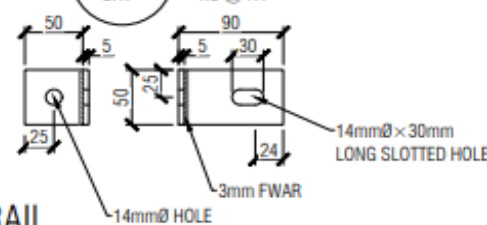

40 TOP RAIL SPLICE ELEVATION

SHT - 1:10 @ A3

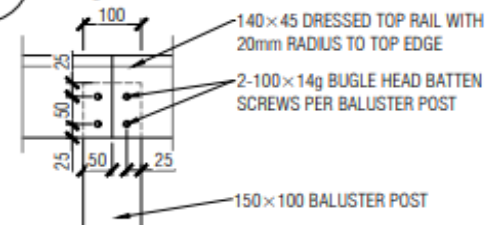

41 TOP RAIL SPLICE PLAN

SHT - 1:10 @ A3

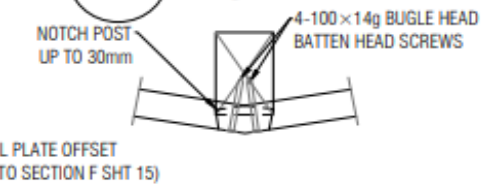

39 APEX TOP RAIL

SHT - 1:20 @ A3

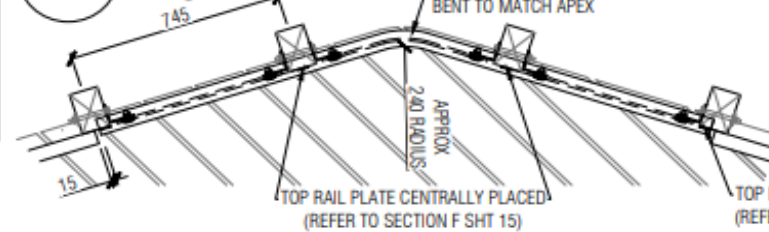

DO NOT SCALE



42 LOW BOARDWALK ELEVATION

SHT - 1:20 @ A3

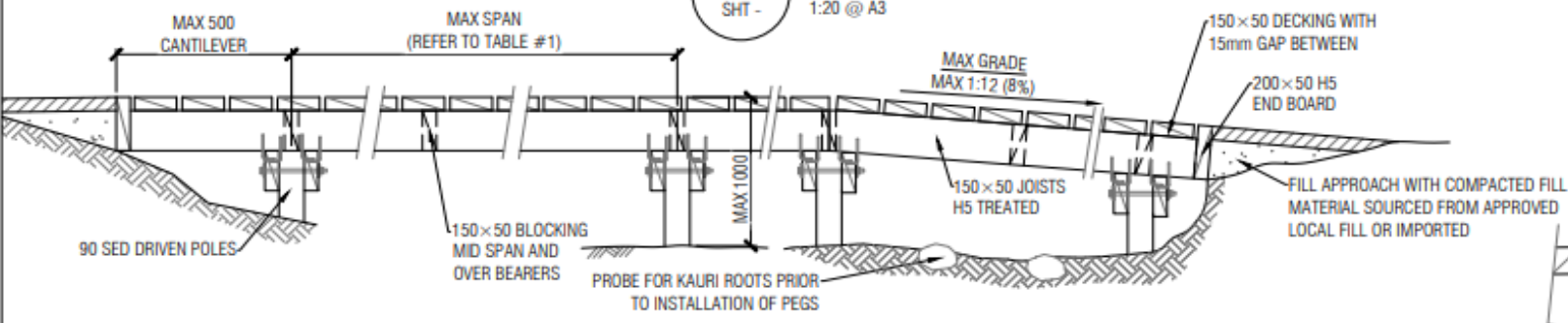
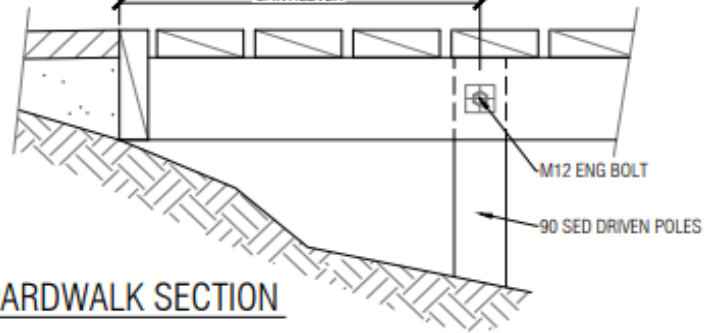

TABLE #1 - LOW BOARDWALK

DECK WIDTH (mm)	1500	1200
MAX SPAN (mm)	2000	1900
PILE SPACING (mm)	1300	1000
MIN PILE DEPTH (mm)	900	900

44 ALTERNATIVE END DETAIL

SHT - 1:10 @ A3
MAX 500 CANTILEVER



G LOW BOARDWALK SECTION

SHT - 1:20 @ A3

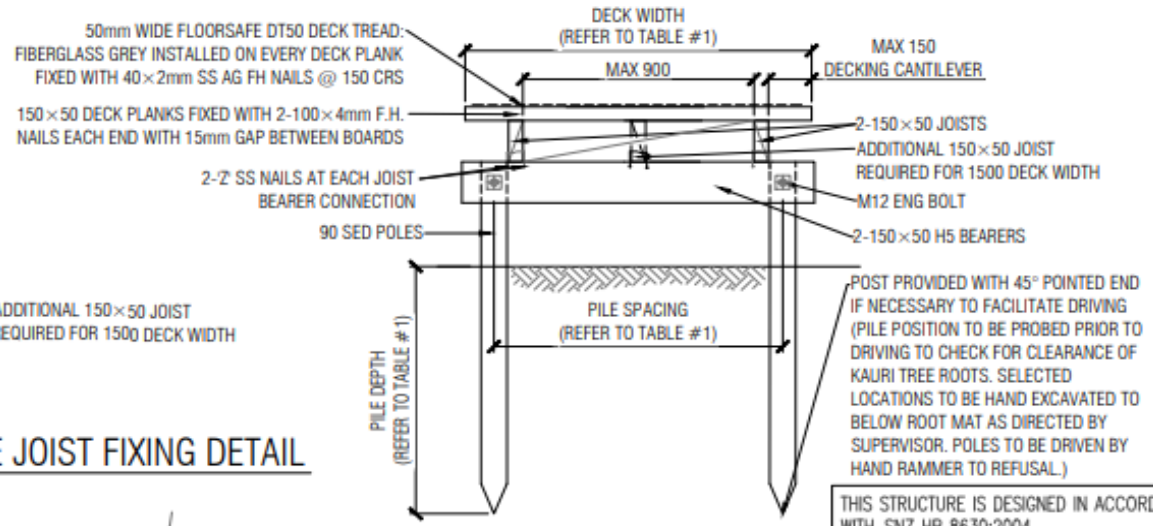

43 TYPICAL CURVE DETAIL

SHT - 1:20 @ A3

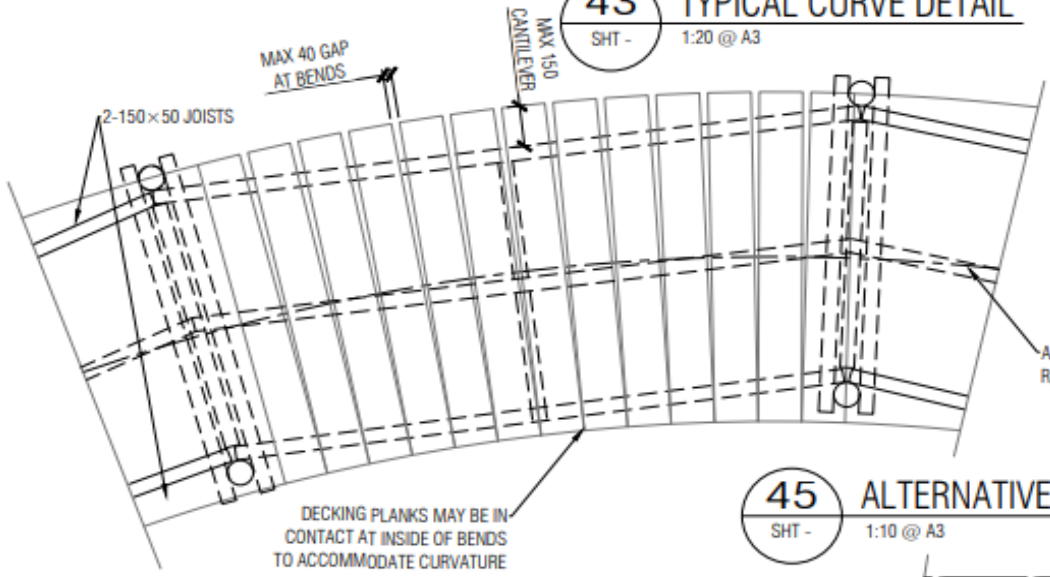

45 ALTERNATIVE JOIST FIXING DETAIL

SHT - 1:10 @ A3

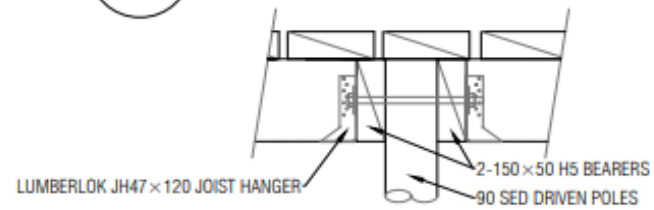

APPLICATION NOTES:
• FOR USE WITHIN HIGH VALUE KAURI HYGIENE AREAS WITH EXTENSIVE SURFACE ROOTS.

THIS STRUCTURE IS DESIGNED IN ACCORDANCE WITH SNZ HB 8630:2004 "TRACKS AND OUTDOOR VISITOR STRUCTURES"

DESIGN DETAILS	
SITE USER GROUP	SST
BARRIER DESIGN LOAD	N/A
DECK DESIGN LOAD	3.2 kPa
EFFECTIVE FALL HEIGHT	<1.5 m

DO NOT SCALE





Legend	
	Renew Existing Track
	Proposed Bridge
	Proposed Staircase / Boardwalk
	Existing Track (No works)
	Decommission Existing Track



Kauri Glen Reserve Stage Three Option Two

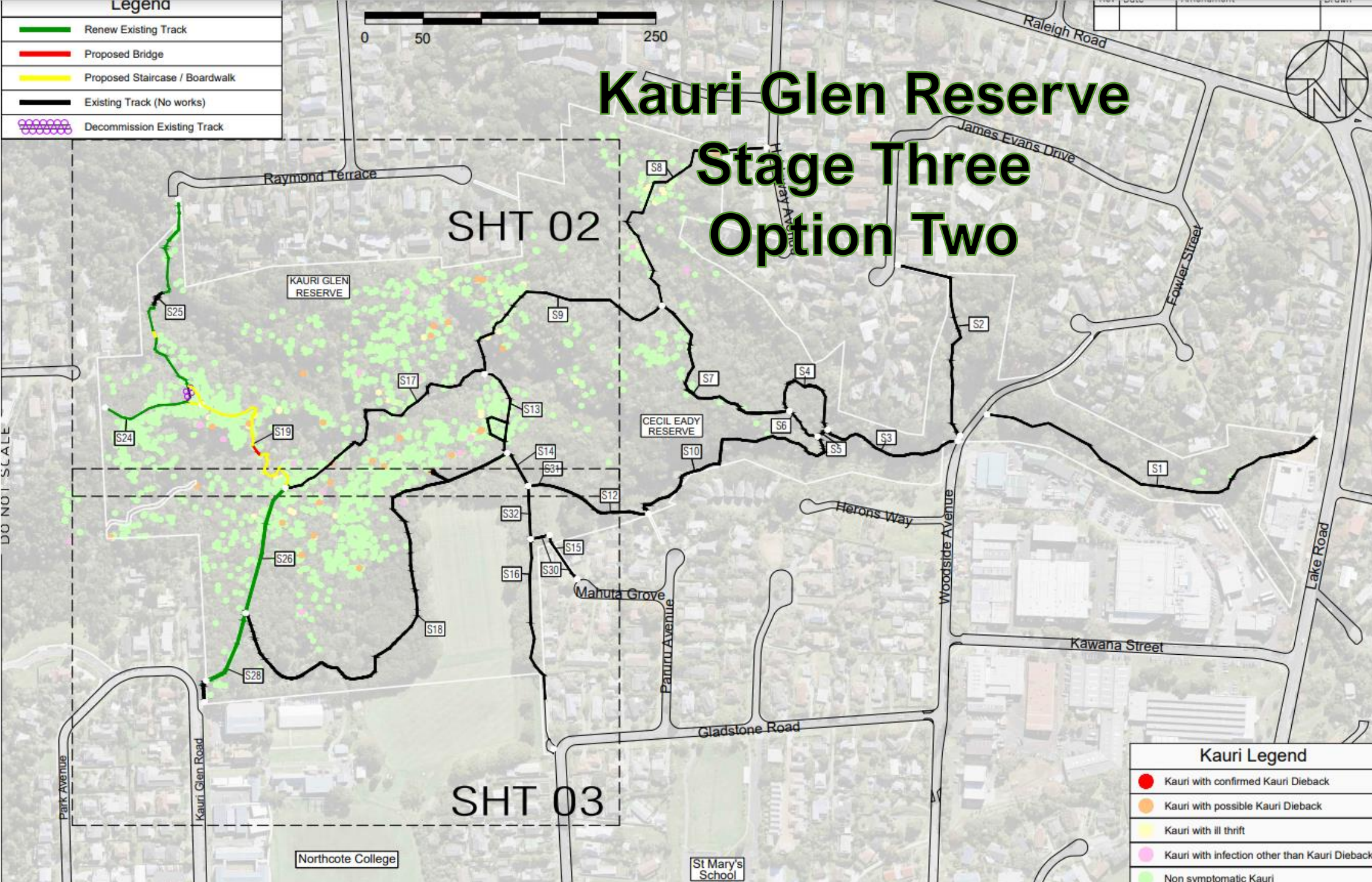

DO NOT SCALE

Kauri Legend	
	Kauri with confirmed Kauri Dieback
	Kauri with possible Kauri Dieback
	Kauri with ill thrift
	Kauri with infection other than Kauri Dieback
	Non symptomatic Kauri

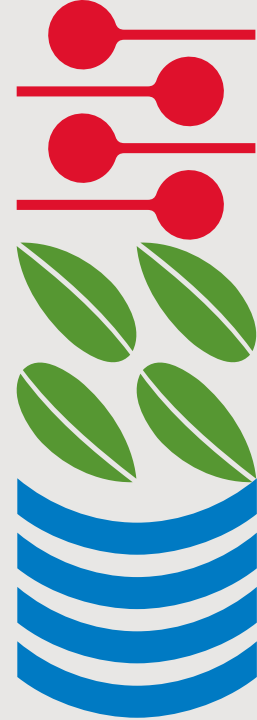

Kauri Glen Stage Three – Option Two

Renewal of path via Long staircase and boardwalk

- Uses the existing benched route but requires upgrades in accordance with national kauri dieback programme track specifications to construct a long staircase to access the bottom of the valley and boardwalk in between. This is the only option that will continue to provide access to the waterfall.
- 1.2m wide x 150m long staircase and boardwalk down the gully and back up
- 10m long bridge would be required to replace existing bridge with a greater perceived impact on kauri root structure than what would be observed for option one.
- There is still work to be complete on the tender package including the costings and detailed plans for the long staircase and the bridge at the bottom of the gully. This would not be ready for tender until January/February 2022.
- Costs: \$669,632 (This is a rough order cost and will require detailed plans)
- The ongoing temporary closures of Raymond and Tui entrances including to the junction of S26 to S28 (during physical Works).
- Upgrade from Raymond and Tui Terrace up to S26 with a hygiene station at each end.
- Helicopter drops will be a necessary part of this project.
- NETR Sponsor have identified this as the preferred option and will pay for this option fully.





0 10m 20m

01 STAIRCASE AND BOARDWALK ELEVATION

SHT - 1:350 @ A3

TO S24, S25

TO S26

DO NOT SCALE

SOUTH SIDE
 1.2m WIDE
 STAIRCASE 35m
 LOW BOARDWALK 10m
 BOARDWALK 18m

1.2m WIDE 10m
 LONG BRIDGE

NORTH SIDE
 1.2m WIDE
 STAIRCASE 36m
 LOW BOARDWALK 10m
 BOARDWALK 31m

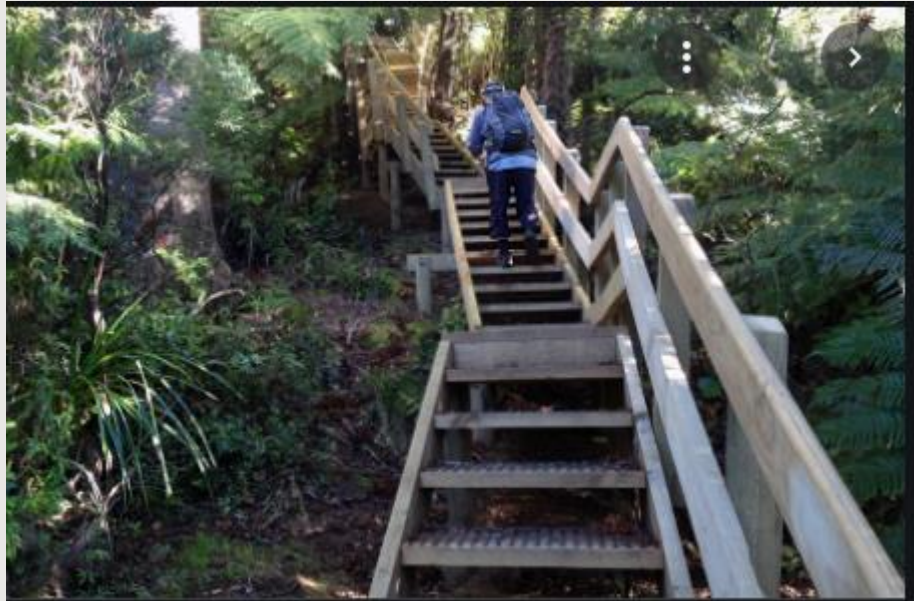

02

STAIRCASE AND BOARDWALK SOUTH ELEVATION

SHT - 1:200 @ A3

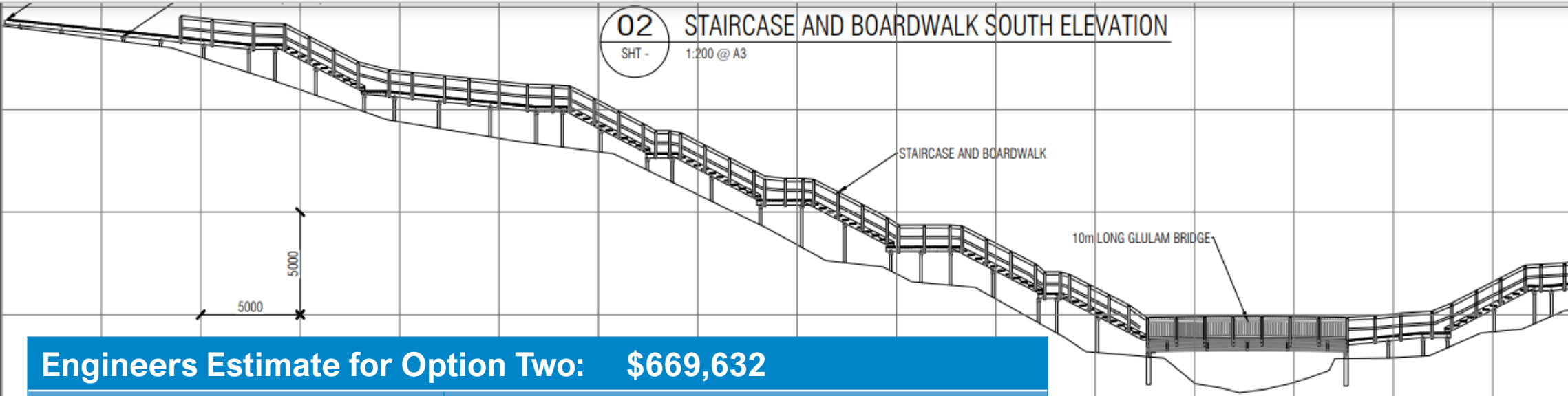

Engineers Estimate for Option Two: \$669,632	
NETR Contribution	Kaipatiki Capex Contribution
\$669,632	\$0

03

STAIRCASE AND BOARDWALK NORTH ELEVATION

SHT - 1:200 @ A3

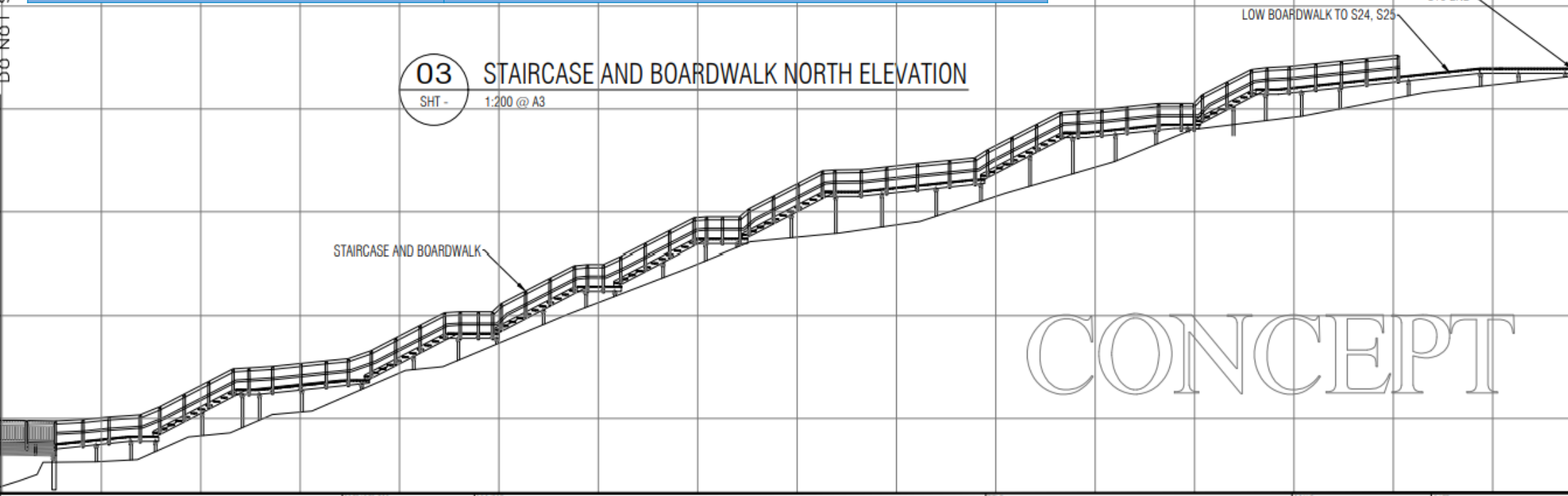

CONCEPT

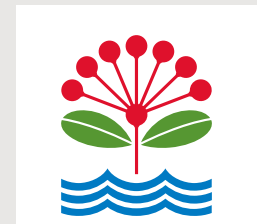
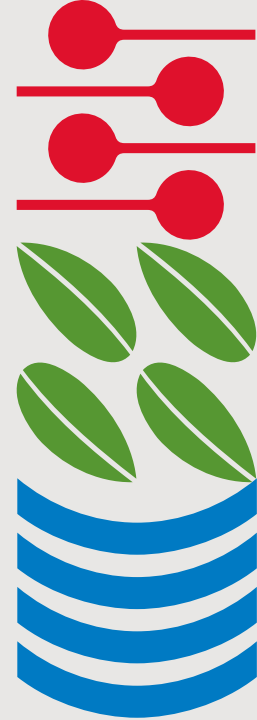

DO NOT SCALE

Legend	
	Renew Existing Track
	Proposed Bridge
	Proposed Staircase / Boardwalk
	Existing Track (No works)
	Decommission Existing Track



Kauri Glen Reserve Stage Three Option Three

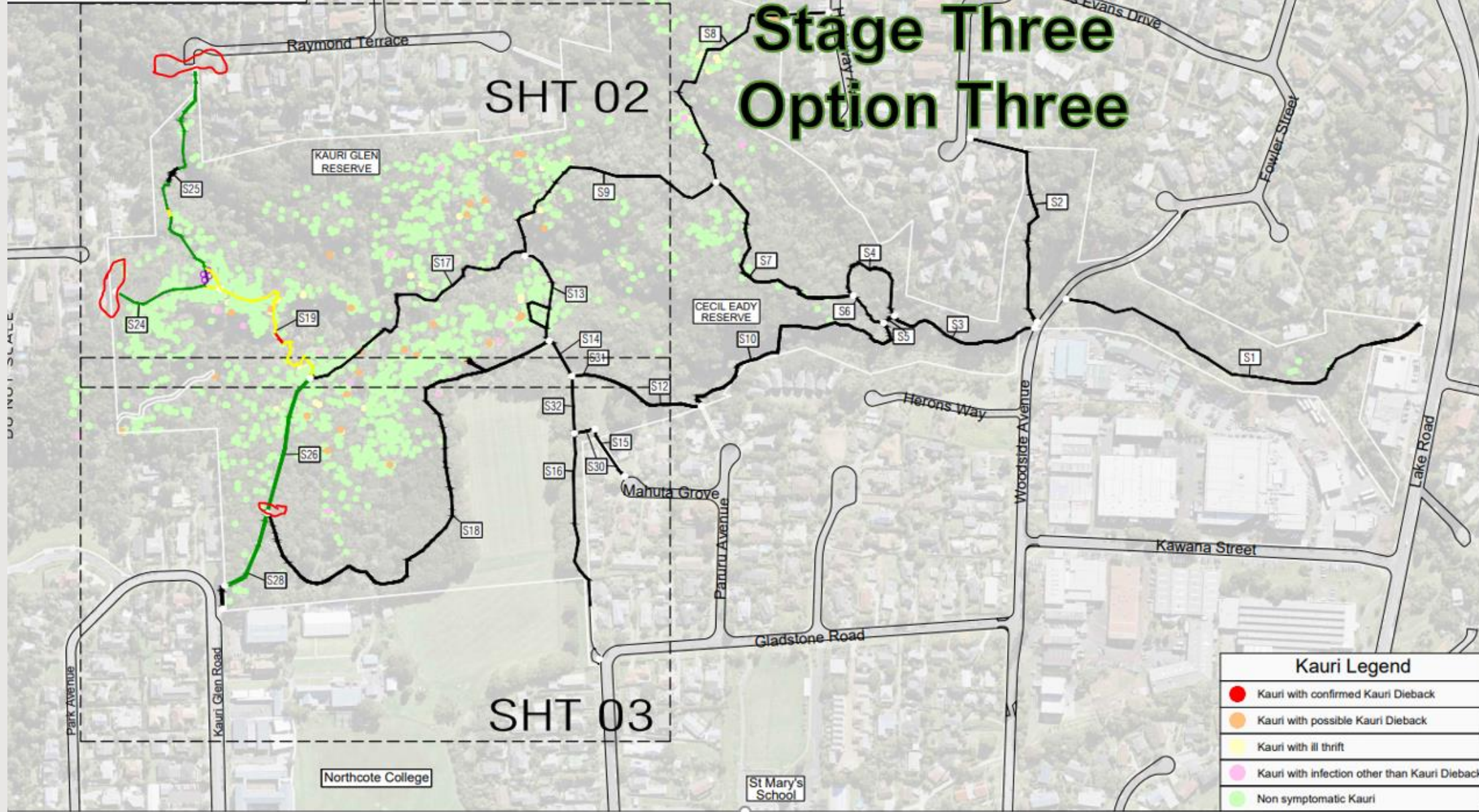

Kauri Legend	
	Kauri with confirmed Kauri Dieback
	Kauri with possible Kauri Dieback
	Kauri with ill thrift
	Kauri with infection other than Kauri Dieback
	Non symptomatic Kauri







Kauri Glen Stage Three – Option Three

Tui and Raymond Terrace remain Closed

- Important to always have the option to remain closed
- Main issues with this as that people will always find ways of getting around the fences.
- This option was not discussed with the 4 stakeholder groups.
- This would then require permanent fencing at Raymond and Tui and at the start of S28 and S26 (as identified on the map)
- This is not the proposed option by staff



Analysis of Options One and Two

	Option One	Option Two
Forest Health	An Arborist report has been completed for this option and the major positives identified was that his option pulls away the track from the existing kauri trees and the board provides less kauri trees being disturbed.	The proposed staircase and bridge will remain on the existing layout with driven piles of up to 70m
Recreational		
All Ability Access	The boardwalk bridge will provide a step free link from Tui to Kauri Glen Road and through to Mahuta Road.	Users will be able to gain entry from Tui Road into the forest but will be unable to go up and down the stairs
User experience	All ability users including wheelchairs/push chairs and will enable people to experience a bush top walkway through the forest	Provides a good hike and workout with the staircase and there is a view where the current bridge is of the waterfall. This will be lost if option one is approved.
Kaipatiki Network Plan		
Physical Works Costs	\$1,009,820	\$669,632



Options One - Tree Top Walkway/Bridge

Options Two - Upgrade of existing walkway

Ratio Points

1 = Excellent = 10

2 = Good = 6

3 = Poor = 3

	Forest Health	Recreation	All ability Access	Experience for Visitors	Kaipatiki Network Plan	Physical Works Costs	TOTAL SCORE
Option One	2	1	1	1	1	2	52
Option Two	2.5	1	3	1	2	1	44



Feedback on Options One and Two

Consultation Group	Option Preferred	Commentary
Northcote College	Option One	<ul style="list-style-type: none"> • H&S perspective is better for kids since it will not be down a gully and open to people hiding and having the ability to have clear line of sight for the students. • Likes all ability access for students and families • Would like us to look at bike options for the Tui to Kauri Glen Road • The growth that is happening in Northcote and how many kids will be going to the school will grow this will provide an alternative option for kids to gain entry to the school rather than using the main roads • This reserve would become a true destination and well used with this connection • Signage – look at showing design/true timeframes and updated/alternatives to walking • Would be part of the network tree for updating community on this project via facebook and assembly meetings.
North/West Hui	Option One	<ul style="list-style-type: none"> • At the Hui the Iwi as agreed to the approach that they would defer to Te Kawerau o Maki but liked the option one as it provided best protection for Kauri and the forest.
Te Kawerau ā Maki	Option One	<ul style="list-style-type: none"> • Preferred option for the least amount of work happening down in the gully with the Kauri and forest area • Aware this is high value forest • Were concerned about the number of pathways that were in this park. • Likes the idea of all ability access so that everyone can enjoy the forest • Would like to see interpretive signage in this area to tell the story. • Would like to be kept up to date on progress and would like to be part of any walkovers of this reserve.
Kauri Glen Volunteers Group	Option One	<ul style="list-style-type: none"> • The Committee is strongly in favour of Option 1 due to the positive urban connection; easier access with no steps; less piles and interference with kauri trees; tourist potential. • While the cost may be questioned, this will ultimately reduce higher maintenance costs. Option 1 is not only about reserve management; it is providing an essential part of the street system and is providing for increased recreational demand created by Government and other intensive housing development in the area. • A major user of this reserve, Northcote College, has a budget of \$40m to upgrade its college in the face of a significantly larger student roll. • This track is an important element of the infrastructure of the area, and the suggestion is made those other budgets outside of the natural environmental / reserve budgets could possibly be tapped into. • Look at signage and telling the story as well of the area • Would provide support on putting communications out to the community via facebook and their contact network tree of communication.

Health and Safety

How do we advise Northcote College Students and community on not entering this site during construction.

- Issues with people entering closed off sections
- How do we get the message to people to not enter
- Importance of saving Kauri Trees
- Timeline of physical works 8-10 months
- How do we do informative signage to inform closures
- Do you see the bridge as being a H&S issue

Help us to protect ours and your community on the building of Stage Three



KAURI GLEN RESERVE

COMMUNICATE

How do we communicate to all residents and school users about this project

**PROTECT OUR
KAURI**

Saving our Kauri
Trees are so
important to our
forests

**KEEP PEOPLE
SAFE**

Important to keep
people out of the
physical works area
during construction

**CREATE
CONNECTIONS**

Create connections
for all users to enjoy
Kauri Glen Reserve





- Which option do you prefer?
- If Option One – will you pay the difference from what NETR will provide to complete Option One?
- If yes, a report will come to the local board in October for approval.

